



MOUNTING REFERENCE GUIDE

# Accessories

CIM Cable Integrated Mounting System



# Content

---

<b>General notes</b>	<b>3</b>
<b>How to create part numbers</b>	<b>4</b>
<b>Drawer</b>	<b>5</b>
<b>Tray</b>	<b>7</b>
<b>Infusion Pump Mount</b>	<b>9</b>
<b>Basket</b>	<b>12</b>
<b>Fixings for Drawers, Trays, Infusion Pump Mounts and Baskets</b>	<b>13</b>
<b>Table Column / Floor Column</b>	<b>15</b>
<b>Cable Hook</b>	<b>17</b>
<b>Fixings for Cable Hooks</b>	<b>18</b>
<b>CPU Clamp and Universal Clamp</b>	<b>19</b>
<b>Fixings for CPU Clamps and Universal Clamps</b>	<b>20</b>
<b>Power Supply Holster</b>	<b>21</b>
<b>Fixings for Power Supply Holster</b>	<b>22</b>
<b>Wall Channel and European Rail</b>	<b>23</b>
<b>Keyboard Tray</b>	<b>24</b>
<b>Fixings for Keyboard Trays</b>	<b>25</b>
<b>Handle</b>	<b>26</b>
<b>Cable Management</b>	<b>28</b>
<b>Miscellaneous</b>	<b>29</b>

## General notes

---

### Product marking

All CIM products are CE marked. As **medical product risk class 1** and they conform with the regulations MDD 93/42 ECC and EN 60601-1, 3rd Edition. TUEV reports for numerous products especially for anaesthesia applications guarantee electrical and mechanical safety of our products and are available upon request.

### Custom-designed solutions

Please contact us for **custom-designed** solutions.



# How to create part numbers

Part numbers can be easily created by following the steps below:

Please replace the letters in **green** with the part no. code as per your requirements.

### 3. Specify where you want to mount the arm and select the fixing (Y):

1V	=	pole ø 23 - 40 mm / 0.9 - 1.6"
1	=	pole ø 25 mm / 1.0"
1F	=	pole ø 35 mm / 1.4"
1C	=	pole ø 38 mm / 1.5"
2F	=	horizontal rails 10 x 25, 8 x 35, 10 x 30, 10 x 50 mm
3	=	vertical rail 10 x 25 mm
3DR	=	dual vertical rails, distance 150 mm/ 5.9"
3TX	=	dual vertical rails, distance 225 mm/ 8.9"
4V	=	vertical wall channel
4Z	=	vertical wall channel (only for accessories, not for support arms)
4ZH	=	horizontal wall channel (only for accessories, not for support arms)
5	=	horizontal rails 10 x 25, 8 x 35, 10 x 30 mm
6H / 6R	=	horizontal rails 10 x 25, 8 x 35, 10 x 30, 10 x 50 mm
6V	=	vertical rails 10 x 25, 8 x 35, 10 x 30, 10 x 50 mm
70	=	non-height adjustable arms
71	=	height adjustable arms

### 2. Choose the colour requested for decorative parts (C):

bl	=	RAL 5013 (blue)
gr	=	RAL 7024 (graphite grey)
w	=	white (only for drawers, trays, wall channels and handle for carts)
fb	=	ice blue (only for drawers)
e	=	silver (only for handle for carts)

### 3. Choose the colour requested for the aluminium die-cast parts (D):

1	=	RAL 9016 (pure white)
2	=	RAL 9002 (grey white)

## Example

Area of application		Typ of accessory		01 Fixing		02 & 03 Colour
Z	-	SLK	-	Y	.	CD
Z	-	SLK	-	4V	.	bl1

# Drawer

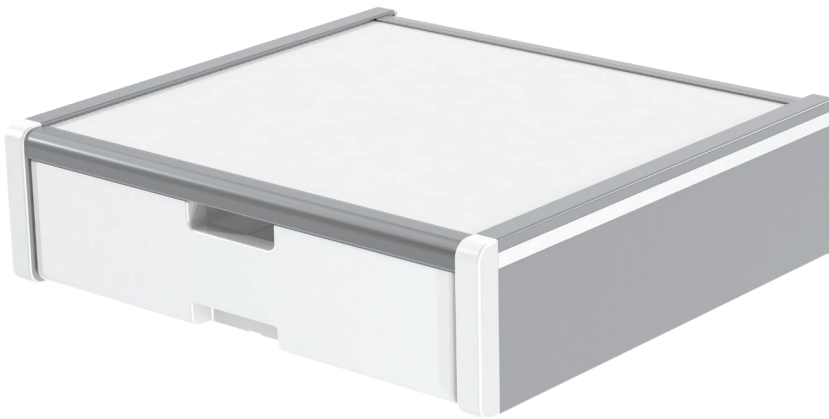

<b>Dimensions</b>	440 x 413 x 120 mm / 17.3 x 16.3 x 4.7" (W x D x H)
<b>Drawer dimensions</b>	375 x 335 x 85 mm / 14.8 x 13.2 x 3.3" (W x D x H)
<b>Material</b>	Aluminium, HPL (high pressure laminate), ABS
<b>Surface</b>	Anodized, HPL and ABS (= scratch-proof, resistant against impact and disinfectants)
<b>Colours to choose</b>	Ice blue fb or white w
<b>Max. load capacity</b>	25 kg / 55.1 lbs (4-fold safety)
<b>Drawer max. weight</b>	5 kg / 11 lbs
<b>Part number console with drawer</b>	Z-SLK-Y.C

## OPTIONAL

<b>European Rail</b>	10 x 25 mm, to be mounted to left and/ or right side of the drawer
<b>Part number European Rail</b>	Z-SLK-NS      1 piece

## Fixings

Y | details page 13

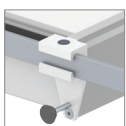

2F

Fixed rail clamp

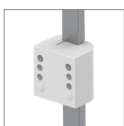

3

Vertical rail clamp



3DR  
3TX

Dual vertical rail clamp



4V

Adapter for vertical wall channel



1V

Universal pole clamp



1  
1F  
1C

Fixed pole clamp

# Drawer

## Technical data

---

### SIDE VIEW

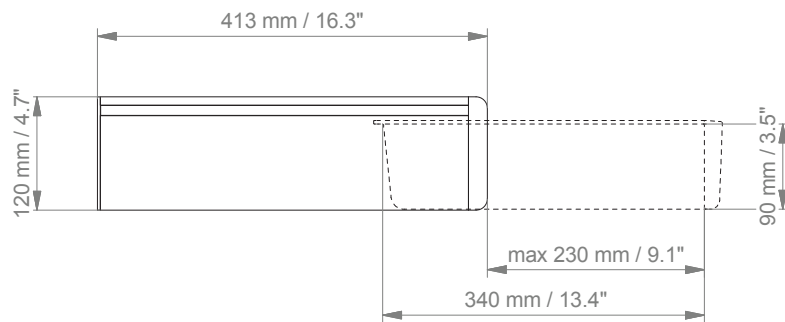

### TOP VIEW

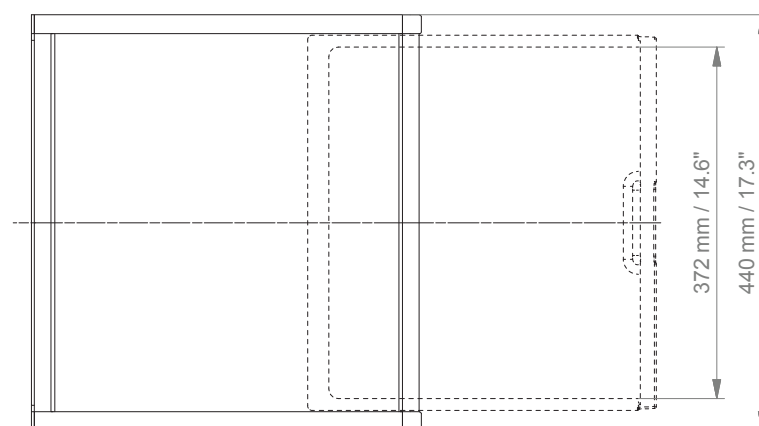

# Tray



<b>Dimensions</b>	435 x 410 x 47 mm / 17.2 x 16.1 x 1.9" (W x D x H)
<b>Material</b>	Steel, powder-coated RAL 9016
<b>Colour</b>	White w
<b>Maximum weight</b>	35 kg / 77.2 lbs (4-fold safety)
<b>Part number</b>	Z-ABL-Y.1

## Fixings

Y | details page 13



2F

Fixed rail clamp



3

Vertical rail clamp



4V

Adapter for vertical wall channel



1V

Universal pole clamp

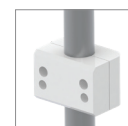

1  
1F  
1C

Fixed pole clamp

# Tray HPL

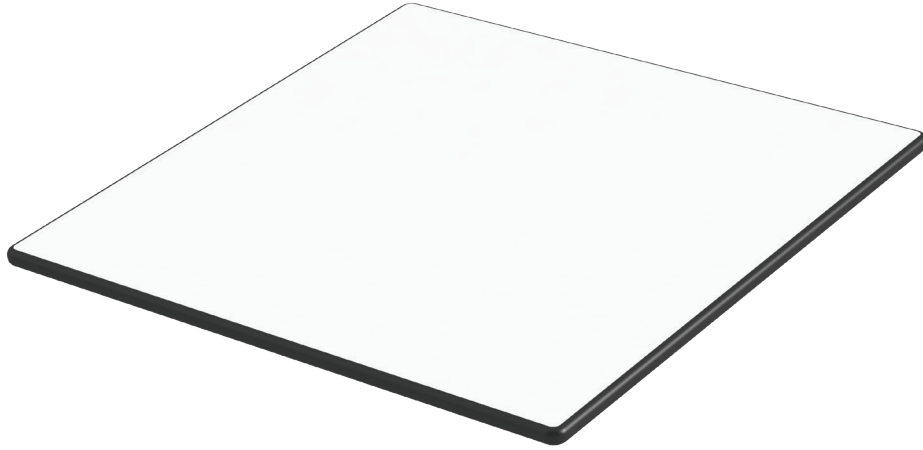

<b>Dimensions</b>	450 x 450 x 12 mm / 17.7 x 17.7 x 0.5" (W x D x H)
<b>Material</b>	HPL (high pressure laminate)
<b>Colour</b>	White w
<b>Maximum weight</b>	25 kg / 55 lbs (4-fold safety)
<b>Part number</b>	Z-HPL-Y.w1_45

## Fixings

Y | details page 13



2F

Fixed rail clamp



4Z

Adapter for vertical wall channel



1V

Universal pole clamp



1  
1F  
1C

Fixed pole clamp



# Infusion Pump Mounts - Pivot Arm



**Colours to choose**

Aluminum parts: RAL 9016 pure white / RAL 9002 grey white

**Maximum weight**

15 kg / 33.1 lbs; 23 kg / 50.1 lbs; 30 kg / 66.1 lbs (6-fold safety)

**Part number**

Part number	Arm length	Front pole clamp	Maximum weight
Z-224RR-Y.D	261 mm / 10.3"	ø 25 mm / 1"	30 kg / 66.1 lbs
Z-230RR-Y.D	321 mm / 12.6"	ø 25 mm / 1"	23 kg / 50.1 lbs
Z-240RR-Y.D	421 mm / 16.5"	ø 25 mm / 1"	15 kg / 33.1 lbs

## Fixings

Y | details page 13



2F

Fixed rail clamp

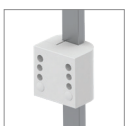

3

Vertical rail clamp



4V

Adapter for vertical wall channel



1V

Universal pole clamp

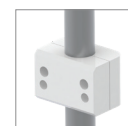

1  
1F  
1C

Fixed pole clamp

# Infusion Pump Mounts - Pivot Arm

Technical data - arm length 261 mm / 10.3"

---

## SIDE VIEW

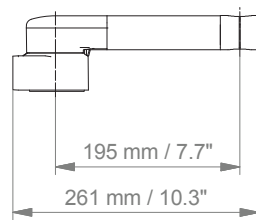

---

## TOP VIEW

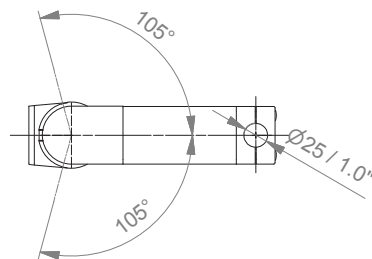

## Infusion Pump Mounts - Accessories



**Material**

Stainless steel

**Part number**

Infusion pole  $\varnothing$  25 mm / 1"

Z-IF\_600          length 600 mm / 23.6"

Z-IF\_1200        length 1200 mm / 47.2"

Infusion pole  $\varnothing$  25 mm / 1" with infusion bag hooks

Z-IF6\_600        length 600 mm / 23.6"

Z-IF6\_1200      length 1200 mm / 47.2"

# Basket

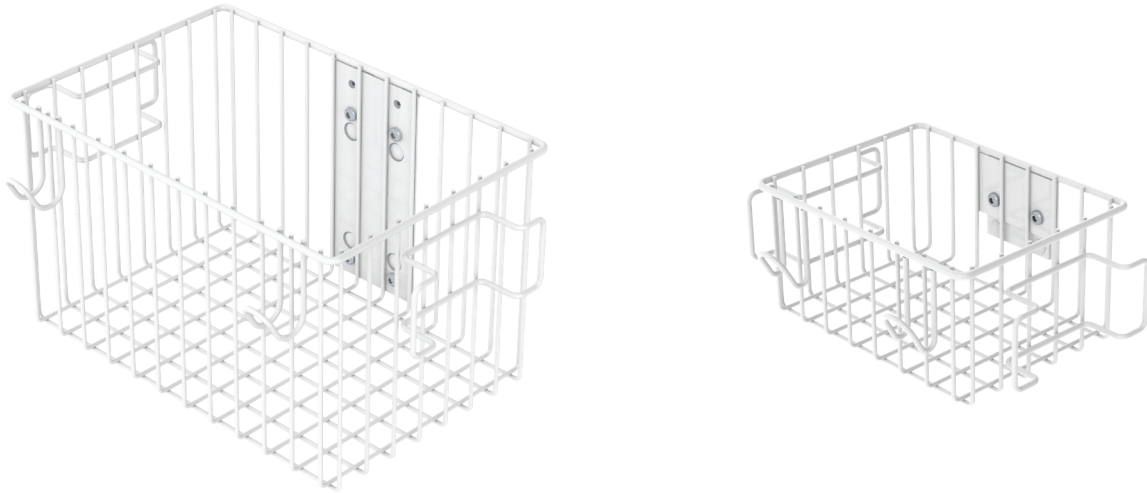

### Dimensions

Basket big: 300 x 200 x 180 mm / 11.8 x 7.9 x 7.1" (W x D x H)

Basket small: 200 x 150 x 100 mm / 7.9 x 5.9 x 3.9" (W x D x H)

### Part number

Z-51-Y basket big

Z-52-Y basket small

### Fixings

Y | details page 13

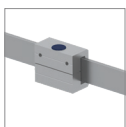

6H  
6R

Universal rail clamp

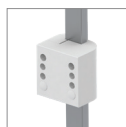

3

Vertical rail clamp



4Z

Adapter for vertical wall channel



1V

Universal pole clamp



1  
1F  
1C

Fixed pole clamp



70

Bracket with swivel function



71

Bracket with swivel function

# Fixings

## for Drawers, Trays, Infusion Pump Mounts and Baskets

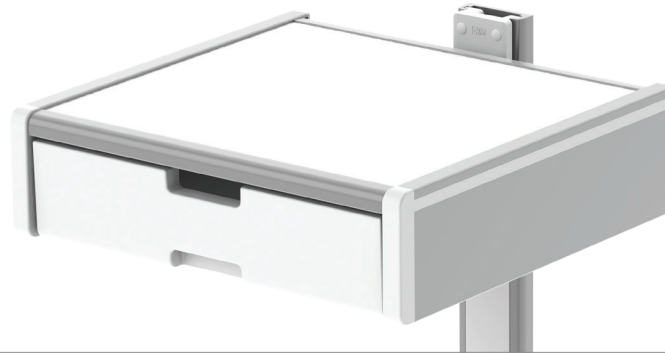











Illustration	Description	Notes	Part no.
	Fixed rail clamp	To mount to horizontal European rails 10 x 25, 8 x 35, 10 x 30, 10 x 50 mm	2F
	Vertical rail clamp	To mount to vertical European rail 10 x 25 mm	3
	Dual vertical rail clamp	To mount to two parallel vertical European rails 10 x 25, 8 x 35, 10 x 30, 10 x 50 mm Distance between rails 150 mm / 5.9", e.g. Dräger pendant Distance between rails 225 mm / 8.9", e.g. Trilux pendant	3DR 3TX
	Adapter for vertical wall channel	H 115 mm / 4.5" To mount to CIM wall channel (compatible with GCX channel)	4V
	Universal pole clamp	V-block to mount to pole $\varnothing$ 23 - 40 mm / 0.9 - 1.6"	1V
	Fixed pole clamp	To mount to pole $\varnothing$ 25 mm / 1.0" To mount to pole $\varnothing$ 35 mm / 1.4" To mount to pole $\varnothing$ 38 mm / 1.5"	1 1F 1C

# Fixings

## for Drawers, Trays, Infusion Pump Mounts and Baskets



Illustration	Description	Notes	Part no.
	Universal rail clamp	To mount to horizontal rail 10 x 25, 8 x 35, 10 x 30, 10 x 50 mm With locking, to mount to horizontal rail	6H 6R
	Adapter for vertical wall channel	To mount to CIM wall channel (compatible with GCX channel)	4Z
	Bracket for basket with swivel function	To mount to non-height adjustable arms	70
	Bracket for basket with swivel function	To mount to height adjustable arms	71

## Table Column / Floor Column



**Floor plate till 800 mm / 31.5" height**

Illustration with height adjustable arm and column height 500 mm / 19.7"



**Floor plate from 800 mm / 31.5" height**

Illustration with height adjustable arm and column height 800 mm / 31.5"

The column profile can be mounted to table or floor. The opposite C-profiles are intended to accept all CIM arms and/or CIM components.

Besides the standard lengths of the column indicated below, individually required lengths are available on request.

**Floor plate till 800 mm / 31.5" height-  
Floor plate from 800 mm/ 31.5" height**

150 x 150 mm / 5.9 x 5.9", hole pattern 126 x 126 mm / 5 x 5"  
180 x 180 mm / 7.1 x 7.1", hole pattern 126 x 126 mm / 5 x 5"

**Part number column**

H 800 mm / 31.5"  
T-CTP-60.w\_800

H 1600 mm / 63"  
T-CTP-63.w\_1600

Further length on request.

# Table Column / Floor Column

## Technical data

FLOOR PLATE TILL 800 MM / 31.5" HEIGHT

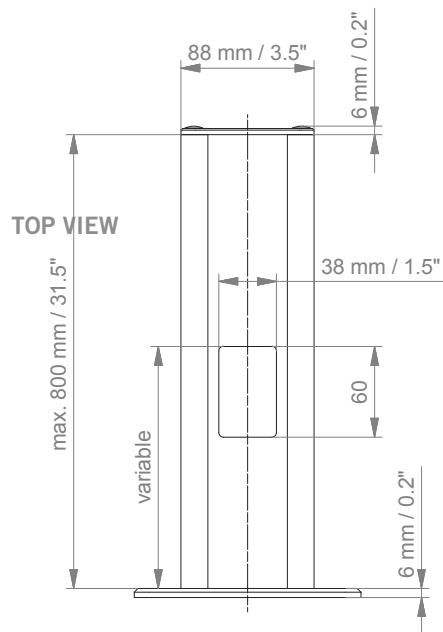
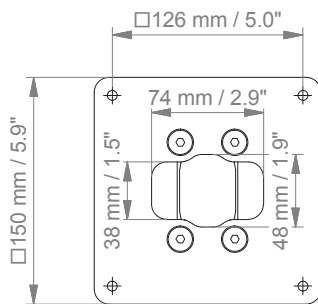



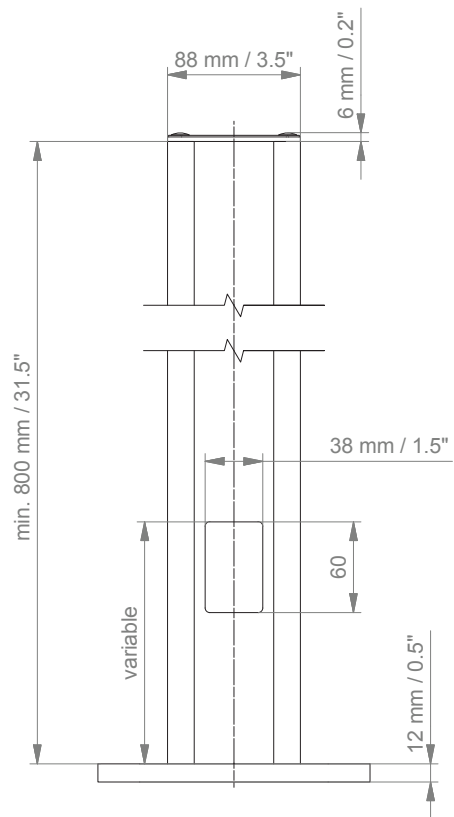
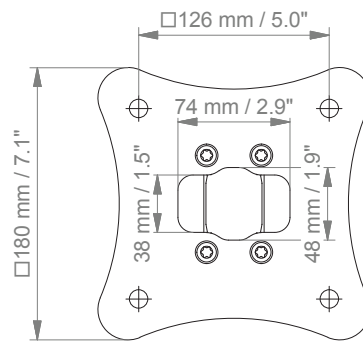

FLOOR PLATE FROM 800 MM / 31.5" HEIGHT









# Cable Hook

Illustration	Description	Fixing	Part no.
	<p><b>Dual cable hook</b></p> <p>To mount to front joint of arm</p>	<p>To mount to non-height adjustable arms</p> <p>To mount to height adjustable arms</p>	<p>Z-KH2-70</p> <p>Z-KH2-71</p>
	<p><b>Dual cable hook</b></p>	<p>Details page 18</p>	<p>Z-KH2-Y</p>
	<p><b>Triple cable hook</b></p> <p>To mount to front joint of arm</p>	<p>To mount to non-height adjustable arms</p> <p>To mount to height adjustable arms</p>	<p>Z-KH3-70</p> <p>Z-KH3-71</p>
	<p><b>Triple cable hook</b></p>	<p>Details page 18</p>	<p>Z-KH3-Y</p>
	<p><b>Down post with cable hook</b></p> <p>To mount to front joint of arm</p>	<p>To mount to non-height adjustable arms</p> <p>Length 150 mm / 5.9"</p> <p>Length 300 mm / 11.8"</p> <p>To mount to height adjustable arms</p> <p>Length 150 mm / 5.9"</p> <p>Length 300 mm / 11.8"</p>	<p>Z-KH6-70_150</p> <p>Z-KH6-70_300</p> <p>Z-KH6-71_150</p> <p>Z-KH6-71_300</p>

# Fixings

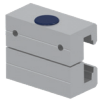
## for Cable Hooks



Illustration	Description	Notes	Part no.
	Without fixing	To mount to bracket with swivel function	0
	Universal rail clamp	To mount to horizontal rail 10 x 25, 8 x 35, 10 x 30, 10 x 50 mm With locking, to mount to horizontal rail 10 x 25, 8 x 35, 10 x 30, 10 x 50 mm	6H 6R
	Vertical rail clamp	To mount to vertical European rail 10 x 25 mm	3
	Adapter for vertical wall channel	To mount to CIM wall channel (compatible with GCX channel)	4Z
	Universal pole clamp	V-block to mount to poles $\varnothing$ 23 - 40 mm / $\varnothing$ 0.9 - 1.6"	1V
	Fixed pole clamp	To mount to pole $\varnothing$ 25 mm / $\varnothing$ 1" To mount to pole $\varnothing$ 35 mm / $\varnothing$ 1.4" To mount to pole $\varnothing$ 38 mm / $\varnothing$ 1.5"	1 1F 1C

## CPU Clamp and Universal Clamp

Illustration	Description	Notes	Part no.
	<p><b>CPU dual clamp set</b></p> <p>Existing of:            2 clamps (top and bottom)            2 fixings for vertical wall channel</p>	<p>CPU width            27 - 45 mm / 1.1 - 1.8"            45 - 70 mm / 1.8 - 2.8"            60 - 100 mm / 2.4 - 3.9"            85 - 150 mm / 3.3 - 5.9"</p> <p>With extension plate            130 - 170 mm / 5.1 - 6.7"            170 - 215 mm / 6.7 - 8.5</p>	<p>Z-CPU-4.D_27            Z-CPU-4.D_45            Z-CPU-4.D_60            Z-CPU-4.D_85</p> <p>Z-CPU-4.D_130            Z-CPU-4.D_170</p>
	<p><b>Universal clamp</b></p> <p>Adjustable from            35 - 57 mm / 1.4 - 2.3"            48 - 63 mm / 1.9 - 2.5"</p>	<p>Details page 20</p>	<p>Z-UK-Y.D_35            Z-UK-Y.D_48</p>

# Fixings

## for Universal Clamps

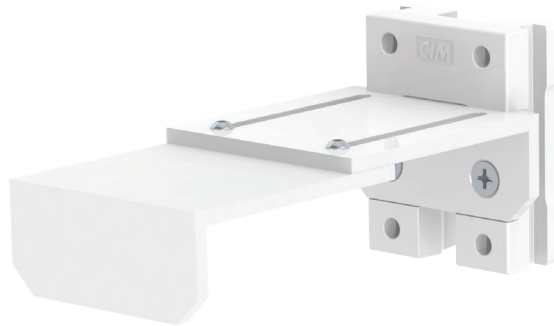



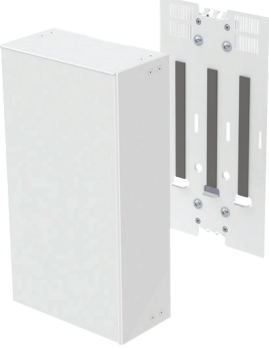



Illustration	Description	Notes	Part no.
	Universal pole clamp	V-block to mount to poles $\varnothing$ 23 - 40 mm / $\varnothing$ 0.9 - 1.6"	1V
	Universal rail clamp	To mount to horizontal rail 10 x 25, 8 x 35, 10 x 30, 10 x 50 mm With locking, to mount to horizontal rail 10 x 25, 8 x 35, 10 x 30, 10 x 50 mm	6H 6R
	Adapter for wall channel	To mount to vertical CIM wall channel (compatible with GCX channel) To mount to horizontal CIM wall channel (compatible with GCX channel)	4Z 4ZH





# Power Supply Holster

Illustration	Description	Notes	Part no.
	<p><b>Power supply enclosure</b></p> <p>Double 255 x 115 x 85 mm            Double 10 x 4.5 x 3.4”            Triple 255 x 165 x 85 mm            Triple 10 x 6.5 x 3.4”            (Dimensions H x W x D)</p>	<p>Details page 22</p>	<p>Z-PS2-Y.1  Z-PS3-Y.1</p>
	<p><b>Power supply holster</b></p> <p>143 x 126 x 48 mm            5.6 x 5 x 1.9”            (Dimensions H x W x D)</p> <p>Universal power supply holster            for different sizes</p>	<p>Details page 22</p>	<p>Z-NH-Y.1</p>

# Fixings

## for Power Supply Holster



Illustration	Description	Notes	Part no.
	Universal rail clamp	To mount to horizontal rail 10 x 25, 8 x 35, 10 x 30, 10 x 50 mm	6H
	Universal rail clamp	To mount to vertical rail 10 x 25, 8 x 35, 10 x 30, 10 x 50 mm	6V
	Adapter for vertical wall channel	To mount to vertical CIM wall channel (compatible with GCX channel)	4Z
	Universal pole clamp	V-block to mount to poles $\varnothing$ 23 - 40 mm / $\varnothing$ 0.9 - 1.6"	1V
	Fixed pole clamp	To mount to pole $\varnothing$ 25 mm / $\varnothing$ 1" To mount to pole $\varnothing$ 35 mm / $\varnothing$ 1.4" To mount to pole $\varnothing$ 38 mm / $\varnothing$ 1.5"	1 1F 1C

## Wall Channel and European Rail

Illustration	Description	Length	Part no.
	<p><b>CIM wall channel</b></p> <p>Vertical wall channel including channel cover and end caps</p> <p>Individual lengths on request!</p> <p>Channel cover available in two colours: white or graphite grey.</p>	<p>480 mm / 18.9" 720 mm / 28.3" 960 mm / 37.8" 1200 mm / 47.2"</p>	<p>Z-WK.C_480 Z-WK.C_720 Z-WK.C_960 Z-WK.C_1200</p>
	<p><b>European rail 10 x 25 mm</b></p> <p>To mount to CIM wall channel including adapter for vertical wall channel</p>	<p>300 mm / 11.8" 400 mm / 15.7" 500 mm / 19.7"</p>	<p>Z-NS-4Z.1_300 Z-NS-4Z.1_400 Z-NS-4Z.1_500</p>

# Keyboard Tray

Illustration	Description	Length	Part no.
	<b>Keyboard tray with fold-up function</b>	300 x 210 mm / 11.8 x 8.3" 400 x 150 mm / 15.8 x 5.9" 500 x 200 mm / 19.7 x 7.9" 580 x 200 mm / 22.8 x 7.9"	Z-EF-Y.CD_30S Z-EF-Y.CD_40S Z-EF-Y.CD_50S Z-EF-Y.CD_58S
	<b>Keyboard tray with fold-up function and left/ right retractable mouse tray</b>	480 x 220 mm / 18.9 x 8.7"	Z-EF-Y.CD_RC
	<b>Keyboard tray retractable and with fold-up function</b>	500 x 200 mm / 19.7 x 7.9" 580 x 200 mm / 22.8 x 7.9"	Z-ER-Y.CD_50S Z-ER-Y.CD_58S

## Fixings

Y | details page 25



5

Fixed rail clamp

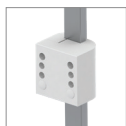

3

Vertical rail clamp



4V

Adapter for vertical wall channel



1V

Universal pole clamp



1

1F

1C





Fixed pole clamp





# Fixings

## for Keyboard Trays





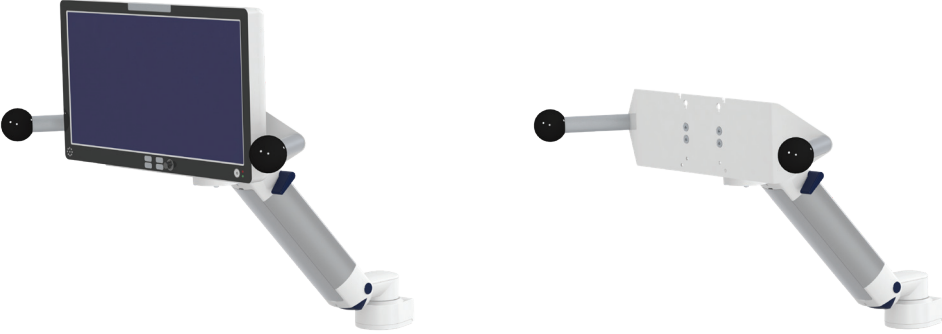

Illustration	Description	Notes	Part no.
	Fixed rail clamp	To mount to horizontal European rail 10 x 25, 8 x 35, 10 x 30 mm	5
	Vertical rail clamp	To mount to vertical European rail 10 x 25 mm	3
	Adapter for vertical wall channel	To mount to CIM wall channel (compatible with GCX channel)	4V
	Universal pole clamp	V-block to mount to poles $\varnothing$ 23 - 40 mm / $\varnothing$ 0.9 - 1.6"	1V
	Fixed pole clamp	To mount to pole $\varnothing$ 25 mm / $\varnothing$ 1" To mount to pole $\varnothing$ 35 mm / $\varnothing$ 1.4" To mount to pole $\varnothing$ 38 mm / $\varnothing$ 1.5"	1 1F 1C

# Handle

Illustration	Description	Notes	Part no.
	<p><b>Dual handle with VESA fixing</b></p>	<p>For monitors with a maximum width of 430 mm / 16.9", Product weight: 1.5 kg / 3.3 lbs</p> <p>570 mm / 22.4", Product weight: 1.9 kg / 4.2 lbs</p>	<p>Z-HDG.1_43</p> <p>Z-HDG.1_57</p>
<p>Example of use Z-HDG.1</p> 			
	<p><b>Handle</b></p>	<p>For carts</p> <p>Product weight: 0.8 kg/ 1.8 lbs</p> <p>Colour to choose (C): blue "bl" or withe "w" or silver "e"</p>	<p>Z-HD-4.C1</p>
<p>Example of use Z-HD-4.e1</p> 			



# Handle

Illustration	Description	Notes	Part no.
	<p><b>Handle</b></p>	<p>For monitor mount VESA</p> <p>Product weight: 1 kg / 2.2 lbs</p> <p>Colour to choose (C): graphite grey “gr” or blue “bl”</p>	<p>Z-HD-G.CD</p>
<p>Example of use Z-HD-G</p> <div style="display: flex; justify-content: space-around; align-items: center;">   </div>			
	<p><b>Handle</b></p>	<p>For monitor mount 5”, Mindray and Philips</p> <p>Product weight: 0.5 kg / 1.1 lbs</p> <p>Colour to choose (C): graphite grey “gr” or blue “bl”</p>	<p>Z-HDR-HZ.C</p>
<p>Example of use Z-HDR-HZ</p> <div style="display: flex; justify-content: space-around; align-items: center;">  <div style="text-align: center;">  <p>5” Plunge Plate</p> </div> <div style="text-align: center;">  <p>Philips Table Top Mount</p> </div> <div style="text-align: center;">  <p>Mindray Mounting Adapter</p> </div> </div>			

# Cable Management

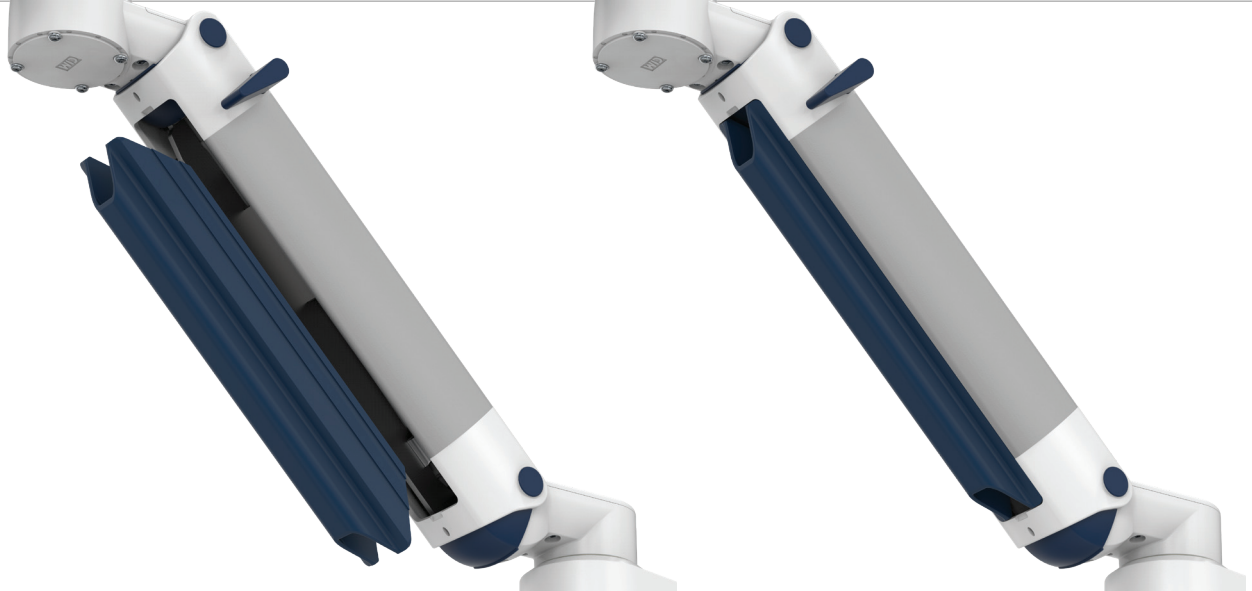
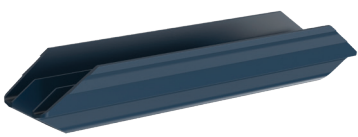



Illustration	Description	Notes	Part no.
	<b>Q-Fit</b>	Cover profile for height adjustable arms  Colour to choose: (C): graphite grey “gr” or blue “bl”	Z-QFIT.C
	<b>Q-Fit</b>	Cover profile for extension	Z-QFIT.EXT
	<b>Cable clip</b>	For down post ø 25 mm, L 100 mm / ø 1”, L 3.9” Colour to choose: (C): graphite grey “gr” or blue “bl”	Z-KC-1.C

## Miscellaneous

Illustration	Description	Notes	Part no.
	<p><b>Down post, rotatable</b></p>	<p>For non-height adjustable arms:            L 150 mm / 5.9", max. load 12 kg / 26.5 lbs            L 300 mm / 11.8", max. load 10 kg / 22 lbs</p> <p>For height adjustable arms:            L 150 mm / 5.9", max. load 12 kg / 26.5 lbs            L 300 mm / 11.8", max. load 10 kg / 22 lbs</p>	<p>Z-DPR-70.CD_150            Z-DPR-70.CD_300</p> <p>Z-DPR-71.CD_150            Z-DPR-71.CD_300</p>
	<p><b>Bottle holder</b></p>	<p>Incl. adapter to mount to            CIM wall channel (compatible with GCX channel)            Please order CIM wall channel separately</p> <p>Max. bottle diameter: 140 mm / 5.5"            Maximum weight: 25 kg / 55.1 lbs            (6-fold safety)</p>	<p>Z-GFH-4.1</p>
	<p><b>Mounting solution for barcode scanner</b></p>	<p>For Z-bracket right hand side</p>	<p>Z-BCS-Mr.1</p>
	<p><b>Mounting solution for barcode scanner</b></p>	<p>Incl. adapter to mount to CIM wall channel            (compatible with GCX channel)</p>	<p>Z-BCS-4Z.1</p>



CIM med GmbH

Euro-Industriepark  
Margot-Kalinke-Str. 9  
80939 Munich / Germany

T +49 89. 978 94 08-0

F +49 89. 978 94 08-29

M [info@cim-med.com](mailto:info@cim-med.com)

[www.cim-med.com](http://www.cim-med.com)

Accessories\_2019.01\_EN

